

iCOLOR COVE EC

The iColor® Cove EC fixture is a Chromasic-driven, low-profile light in the iColor Series, and is designed for accent, perimeter, or cove lighting where lower light intensity and lower costs are desired. iColor Cove EC offers an economical way to bring subtle color-changing light and lighting effects to alcoves, task areas, accent areas, and other tight spaces.

iColor Cove EC is driven by the Color Kinetics® Chromasic® chip. Chromasic is a microchip that integrates power, communication, and control that enables the iColor Cove EC system to lower the cost of digital LED control, making it an affordable alternative for edge and alcove lighting.

The sleek, low-profile design of the iColor Cove EC allows for mounting in small areas, and the easy through-hole mounting feature and in-line power and data connection reduces the installation time. A mounting track is available for linear installations. Each fixture projects a soft-edge strip of light at a 120° by 120° beam angle and comes in fixed lengths of seven (7) and twelve (12) inches.

Power and data are daisy chained from fixture to fixture simplifying installation and making curves and complicated geometry easy to install. Power and data are supplied by PDS-60ca 24V and sPDS-60ca 24V. Both are dedicated Color Kinetics power/data supplies which is available with Ethernet control and DMX512 control. The PDS-60ca 24V is also available with pre-programmed effects. Each power/data supply supports thirty 7-inch or 12-inch fixtures and the compact size allows for discrete installations.

iCOLOR COVE EC SPECIFICATIONS

COLOR RANGE	64 billion (32-bit) additive RGB colors; continuously variable intensity output range
BEAM ANGLE	120° by 120°
SOURCE	15 LEDs (12-inch), 9 LEDs (7-inch) Red, Green, and Blue
HOUSING	Rigid plastic housing
LISTINGS	UL/cUL, CE certified, pending

COMMUNICATION SPECIFICATIONS

DATA INTERFACE	Color Kinetics Chromasic data interface system
CONTROL	Ethernet, DMX512 or stand-alone

ELECTRICAL SPECIFICATIONS (LIGHTS)

POWER REQUIREMENTS	24VDC
POWER CONSUMPTION	2W Max. at full intensity (full RGB)
POWER SUPPLY	Color Kinetics PDS-60ca 24V (Item # 109-000016-00/01/02) and sPDS-60ca 24V DMX/Ethernet (Item # 109-000021-02)

ENVIRONMENTAL SPECIFICATIONS

TEMPERATURE RANGE	-4°F to 122°F (-20°C to 50°C) based on testing of specific product
--------------------------	--

LED SOURCE LIFE

In traditional lamp sources, lifetime is defined as the point at which 50% of the lamps fail. This is also termed Mean Time Between Failure [MTBF]. LEDs are semiconductor devices and have a much longer MTBF than conventional sources. However, MTBF is not the only consideration in determining useful life. Color Kinetics uses the concept of useful light output for rating source lifetimes. Like traditional sources, LED output degrades over time (lumen depreciation) and this is the metric for SSL lifetime.

LED lumen depreciation is affected by numerous environmental conditions such as ambient temperature, humidity, and ventilation. Lumen depreciation is also affected by means of control, thermal management, current levels, and a host of other electrical design considerations. Color Kinetics systems are expertly engineered to optimize LED life when used under normal operating conditions. Lumen depreciation information is based on LED manufacturers' source life data as well as other third party testing. Low temperatures and controlled effects have a beneficial effect on lumen depreciation. Overall system lifetime could vary substantially based on usage and the environment in which the system is installed.

Temperature and effects will affect lifetime. Color Kinetics rates product lifetime using lumen depreciation to 50% of original light output. When the fixture is running at room temperature using a color wash effect, the lifetime is in the range of 30,000-50,000 hours. This is based on LED manufacturers' test data. For more detailed information on source life, please see www.colorkinetics.com/lifetime.

OPTIBIN®

There are inherent variations in the fabrication processes of all semiconductor materials. For LEDs, this variance results in differences in the color and intensity of light output as well as electrical characteristics. Due to these differences, LED manufacturers sort production into "bins," but insuring the availability of a single bin is very difficult. To minimize this issue and achieve optimal color consistency in its products, Color Kinetics has developed and uses a proprietary technology called Optibin. Optibin is an advanced production binning optimization process that minimizes the effects of LED variance for the best possible output uniformity in the final product. Color Kinetics Optibin technology gives the most consistent control of color and intensity from product to product.

CHROMACORE®
BY COLOR KINETICS

CHROMASIC®
BY COLOR KINETICS

OPTIBIN®
BY COLOR KINETICS

ITEM# 101-000022-00 (12-inch)
101-000022-01 (7-inch)

This product is protected by one or more of the following U.S. Patents and their foreign counterparts: 6,016,038, 6,150,774, 6,292,901, 6,340,868, 6,777,891, 6,788,011, 6,806,659, 6,969,954, and 6,975,079. Other patents pending.

©2005-2007 Color Kinetics Incorporated. All rights reserved. Chromacore, Chromasic, CK, the CK logo, Color Kinetics, the Color Kinetics logo, Color Kinetics The Leader in Intelligent Light, ColorBlast, ColorBlaze, ColorBurst, ColorCast, ColorPlay, ColorScape, DIMend, Direct Light, EssentialWhite, eW, iColor, iColor Cove, IntelliWhite, iW, iPlayer, Light Without Limits, Optibin, Powercore, QuickPlay, Sauce, the Sauce logo, and Smartjuice are either registered trademarks or trademarks of Color Kinetics Incorporated in the United States and/or other countries.

All other brand or product names are trademarks or registered trademarks of their respective owners.

BRO126 Rev 06

Specifications subject to change without notice. Refer to www.colorkinetics.com for the most recent version.

iCOLOR COVE EC — 7”

PHOTOMETRIC PERFORMANCE

SOURCE SPECIFICATIONS

Optics: Clear polycarbonate
 Source: 9 LEDs (3 Red, 3 Green, 3 Blue)
 Beam Angle: 120° x 120° (at 50% of peak illuminance)
 Distribution: Symmetric direct illumination
 CCT: Adjustable 1,000–10,000K
 CRI: Not measurable (CIE 13.3-1995)

ILLUMINANCE DISTRIBUTION

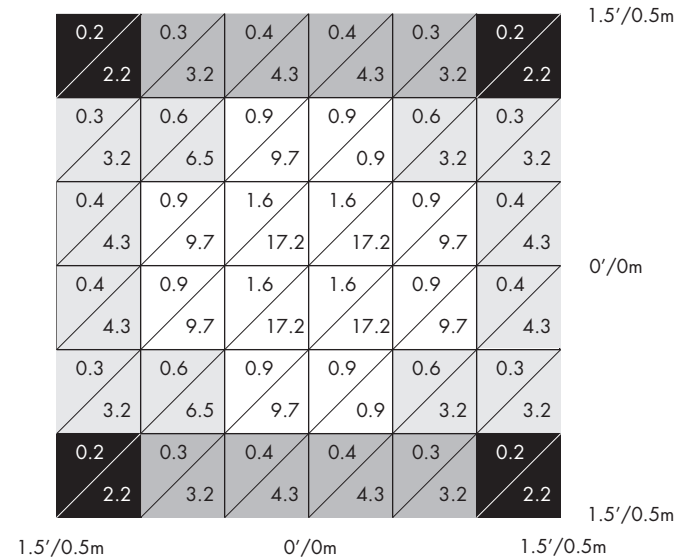

Units: Footcandles/Lux
 Measured on: White
 Distance from surface: 1'/.3m (from center of grid)
 Multipliers: 0.41 Red, 0.23 Green, 0.36 Blue

ILLUMINANCE

COLOR	3'	6'	9'	15'
	1m	2m	3m	5m
WHITE	0.3 3.0	0.1 0.7	0.0 0.3	0.0 0.1
RED	0.1 1.2	0.0 0.3	0.0 0.1	0.0 0.0
GREEN	0.1 0.7	0.0 0.2	0.0 0.1	0.0 0.0
BLUE	0.1 1.1	0.0 0.3	0.0 0.1	0.0 0.0

Measured in Footcandles/Lux on axis.

GAMUT

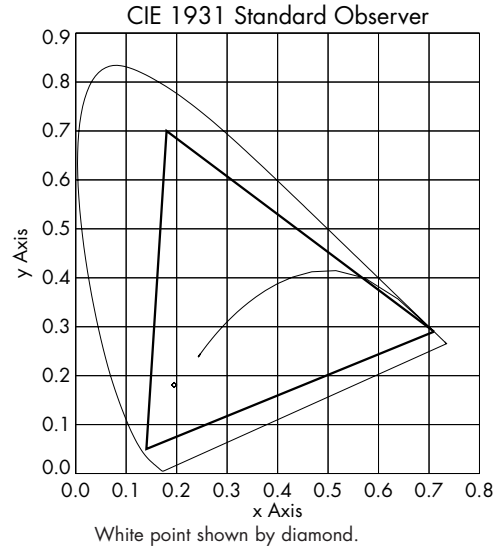

CANDLE POWER DISTRIBUTION

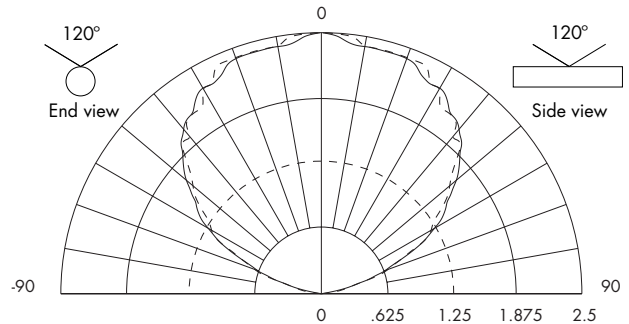

Measured on: White
 Beam center: 2.5 cd
 Thin dashed lined: Indicates 50% of peak
 Multipliers: 0.41 Red, 0.23 Green, 0.36 Blue

TYPICAL LIGHT OUTPUT

COLOR	TOTAL OUTPUT (LUMENS)	POWER (WATTS)	EFFICACY (lm/w)
WHITE	7.0	2.0	3.5
RED	2.8	0.8	3.7
GREEN	1.6	0.8	2.1
BLUE	2.5	0.8	3.3

iCOLOR COVE EC — 12”

PHOTOMETRIC PERFORMANCE

SOURCE SPECIFICATIONS

Optics: Clear polycarbonate
 Source: 15 LEDs (5 Red, 5 Green, 5 Blue)
 Beam Angle: 120° x 120° (at 50% of peak illuminance)
 Distribution: Symmetric direct illumination
 CCT: Adjustable 1,000–10,000K
 CRI: Not measurable (CIE 13.3-1995)

ILLUMINANCE DISTRIBUTION

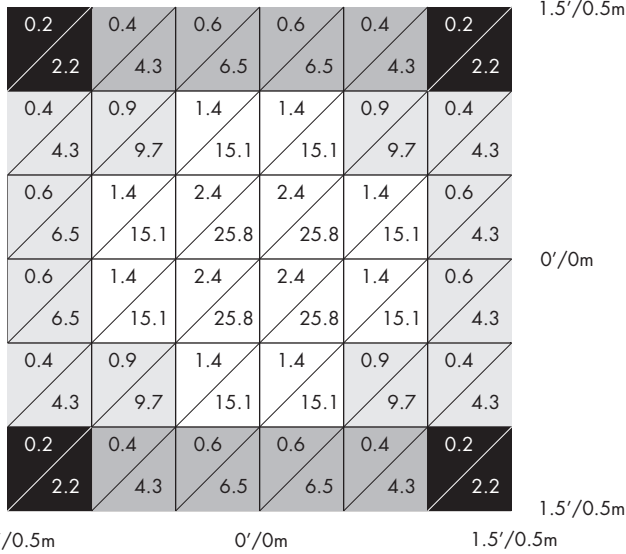

Units: Footcandles/Lux
 Measured on: White
 Distance from surface: 1'/.3m (from center of grid)
 Multipliers: 0.44 Red, 0.19 Green, 0.38 Blue

ILLUMINANCE

COLOR	3'	6'	9'	15'
	1m	2m	3m	5m
WHITE	0.4 4.5	0.1 1.1	0.0 0.5	0.0 0.2
RED	0.2 2.0	0.0 0.5	0.0 0.2	0.0 0.1
GREEN	0.1 0.9	0.0 0.2	0.0 0.1	0.0 0.0
BLUE	0.2 1.7	0.0 0.4	0.0 0.2	0.0 0.1

Measured in Footcandles/Lux on axis.

GAMUT

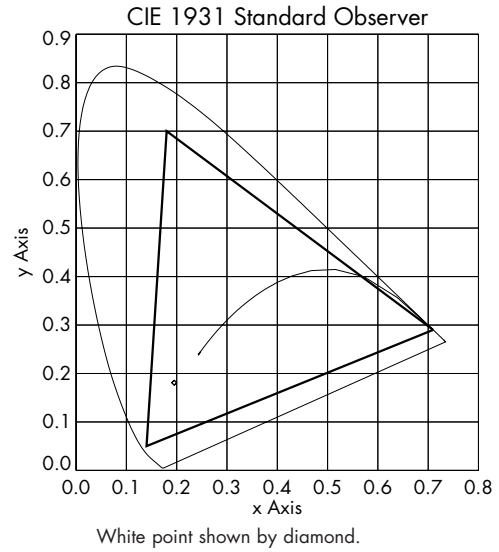

CANDLE POWER DISTRIBUTION

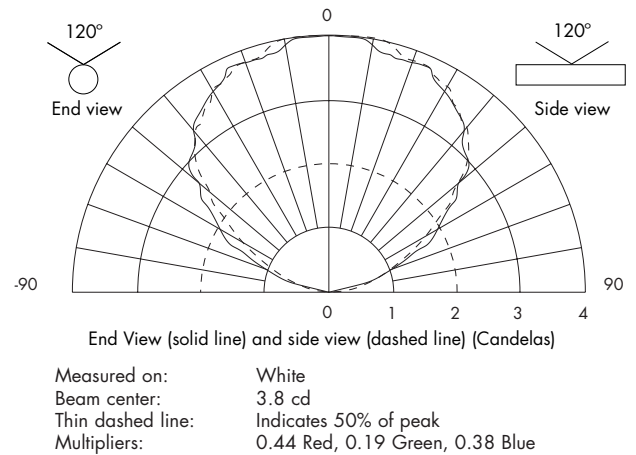

TYPICAL LIGHT OUTPUT

COLOR	TOTAL OUTPUT (LUMENS)	POWER (WATTS)	EFFICACY (lm/w)
WHITE	11.0	2.0	5.6
RED	4.8	0.8	6.2
GREEN	2.1	0.8	2.7
BLUE	4.1	0.8	5.4

iCOLOR COVE EC

PHYSICAL DIMENSIONS

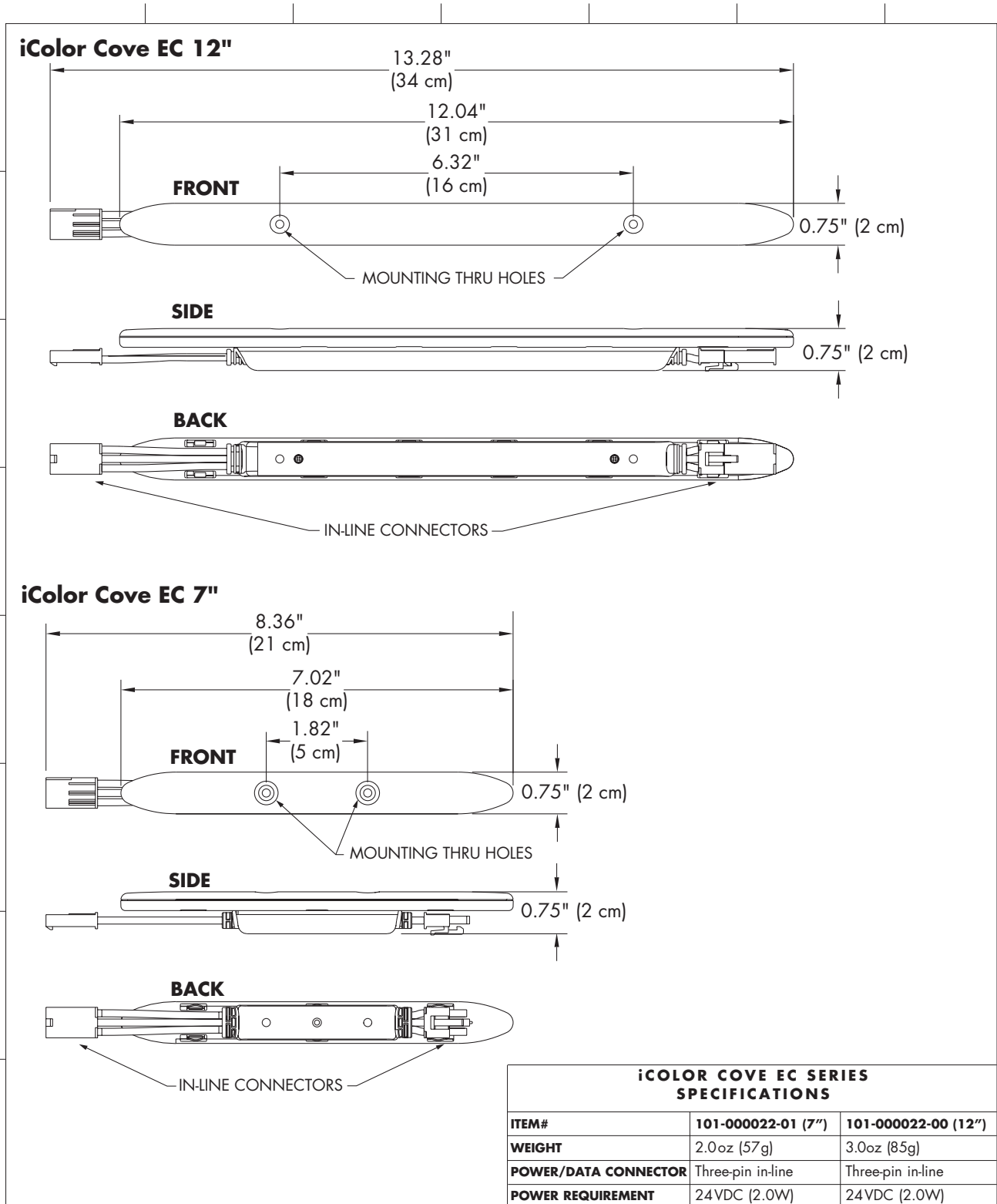

iCOLOR COVE EC

FUNCTIONAL FLOW DIAGRAM

iColor Cove EC Wiring with PDS-60ca 24V

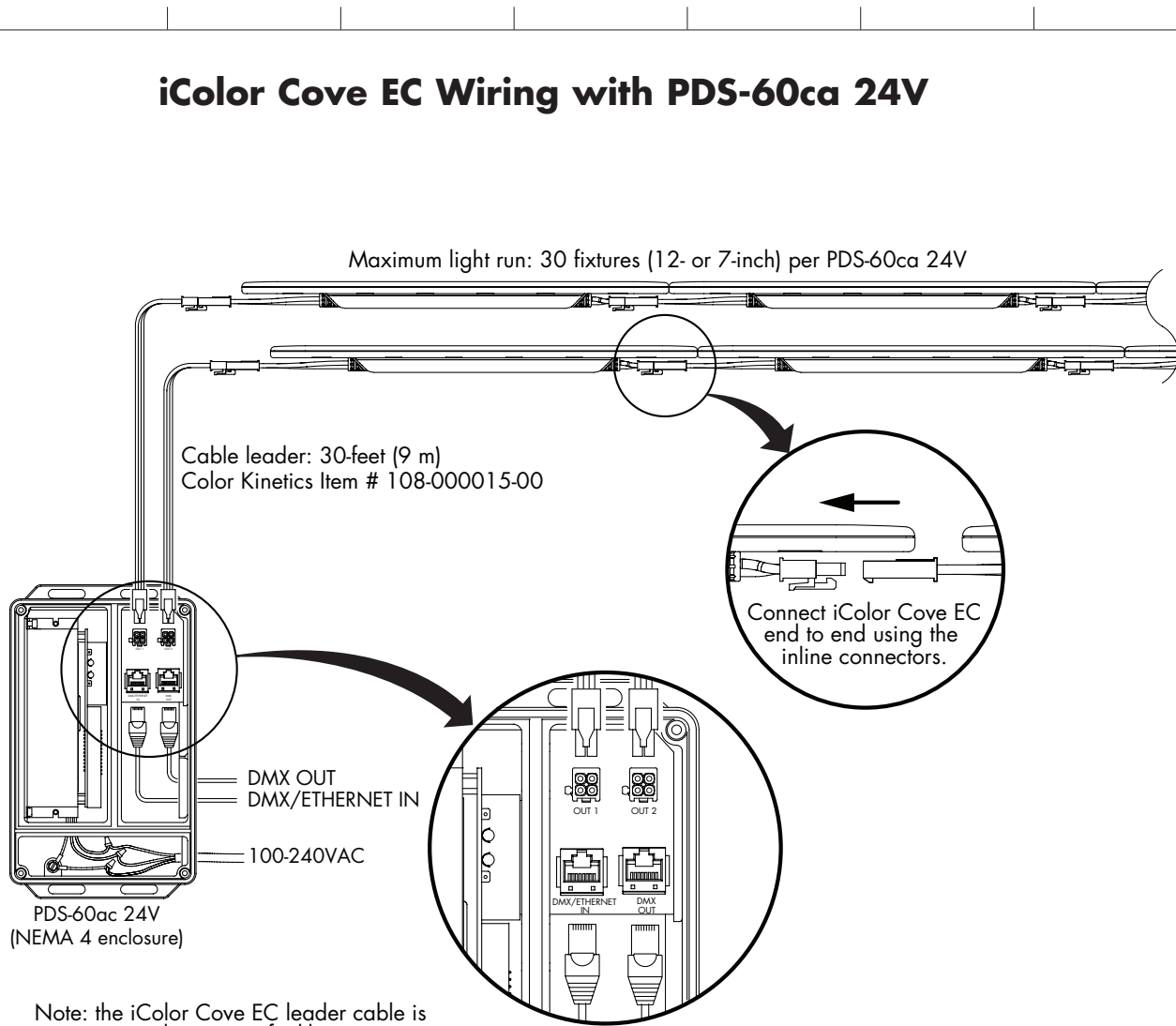

Note: the iColor Cove EC leader cable is connectorized to ensure faultless wiring.
Do not modify, shorten, or lengthen the cable.
Do not remove or replace the factory installed connectors.

For complete installation instructions and safety precautions, refer to the iColor Cove EC User Guide and wiring diagrams located at www.colorkinetics.com/support.

iCOLOR COVE EC

FUNCTIONAL FLOW DIAGRAM

iColor Cove EC Wiring with sPDS-60ca 24V

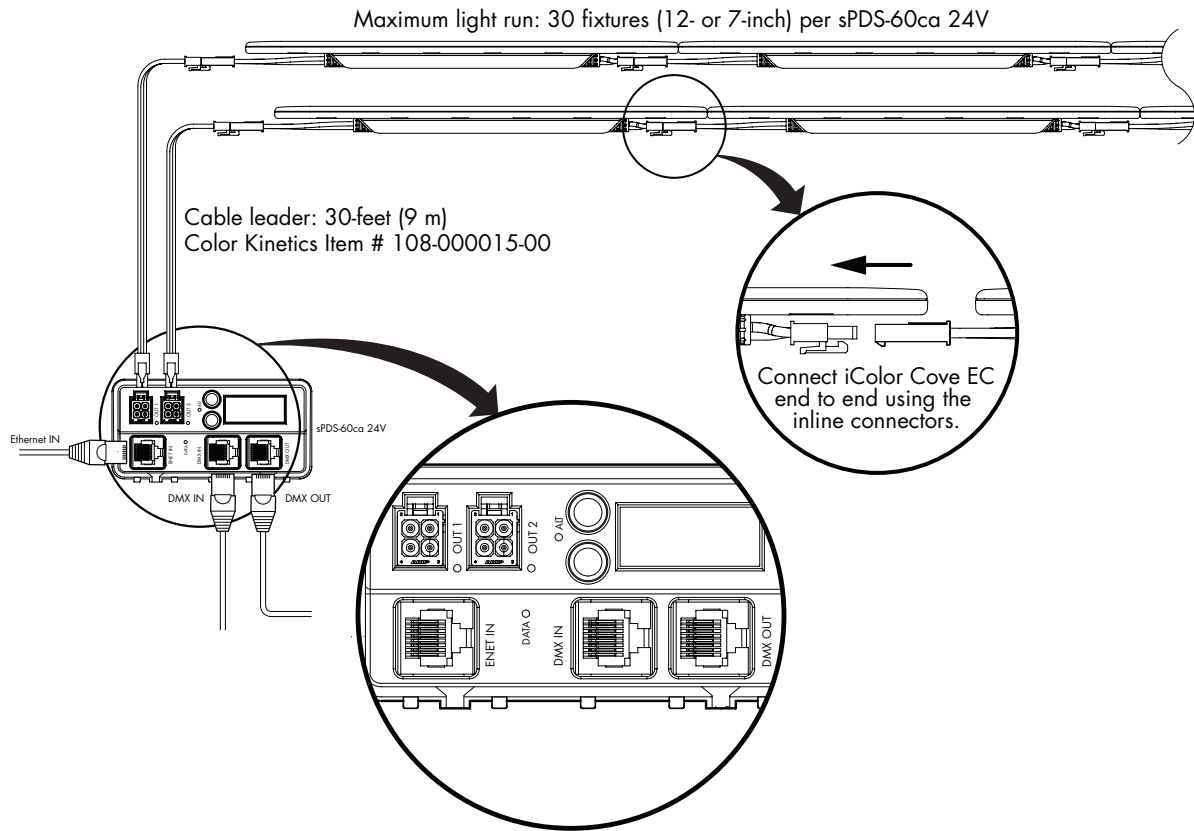

Note: the iColor Cove EC leader cable is connectorized to ensure faultless wiring. Do not modify, shorten, or lengthen the cable. Do not remove or replace the factory installed connectors.

For complete installation instructions and safety precautions, refer to the iColor Cove EC User Guide and wiring diagrams located at www.colorkinetics.com/support.