

4 Conductor Jumper Cable

Date: _____
 Type: _____
 Firm Name: _____
 Project: _____

For use with Graze Compact, 6.1 m (20 ft), Black, UL

JUMPER CABLE

For use with Graze Compact Powercore luminaires



Specifications

Due to continuous improvements and innovations, specifications may change without notice.

Physical

Dimensions	6096 mm (240 in) Length
Weight	1.8 kg (3.97 lb)
Connections	Self-locking, male-female connectors
Cable	4 conductor, Annealed flexible stranded copper, UL 62, UL 1581 and CSA 22.2
Outer Cable Insulation	CPE 105° C, not halogen free
Inner Wire Insulation	EPR (Ethylene Propylene Rubber)
Wire Gauge	14 AWG
Voltage	100 to 277 VAC
Temperature Range	-40 to 50 °C (-40 to 122 °F) Operating

Certification and Safety

Environment	Dry/Damp/Wet Location, IP66
Certification	UL

Dimensions

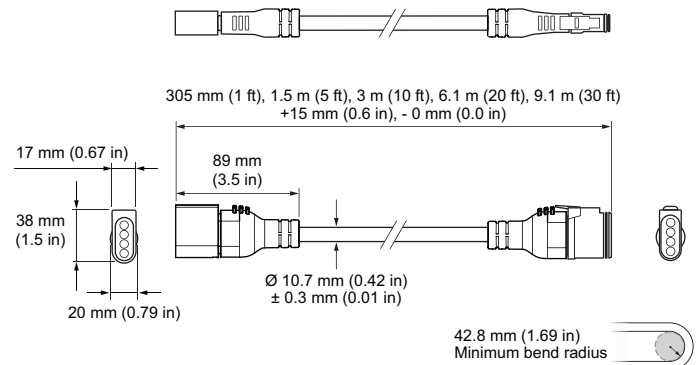

Part Numbers

Jumper Cable

4 Conductor Jumper Cable
 For use with Graze Compact, 6.1 m (20 ft), Black, UL
 Allows end-to-end connection of units with 20 ft gap
 ZCS570 C6096P-M-F BK UL

Use Item Number when ordering in North America.

Item Number	Item 12NC
108-000073-06	912400136936

© 2021 Signify Holding. All rights reserved. Specifications are subject to change without notice. No representation or warranty as to the accuracy or completeness of the information included herein is given and any liability for any action in reliance thereon is disclaimed.

8/10/2021

