

Burst Powercore gen3, IntelliHue

Date: _____

Type: _____

Firm Name: _____

Project: _____

**8° Native (no spread lens), White Housing,
Architectural**

Exterior architectural and landscape spotlight with intelligent white and color light

Burst Powercore gen3, IntelliHue produces high-quality white, pastel, and saturated color light, in the same precisely controllable luminaire for outdoor wall washing and spot lighting applications. IntelliHue technology delivers exceptional CRI and the ability to choose any CCT between 2000 K and 10000 K.



- Expands customization with a wide range of new accessory options. In addition to the native 6° lens, six different spread lenses can customize the luminaire to produce 10°, 20°, 40°, 60°, 80°, and 10° x 40° (asymmetric) beam angles. Three housing color choices (black, gray, and white)—plus the option to add a louver, full glare shield, and half glare shield—create new aesthetic possibilities for designers and architects.
- Color-changing and high-quality white light from the same luminaire —IntelliHue is an advanced approach to color mixing that enables high-quality intelligent color and white light from a single luminaire. Multiple channels of LED light sources combine to produce a full spectrum of precisely controllable light, including millions of saturated colors, pastels, and uniform white light with CRI of greater than 79.5 in the 2700 K to 4000 K range.
- Improves color consistency between all LED luminaires in a family with Chromasync technology. During the manufacturing process a calibrated light measurement device creates an algorithm to define a common color gamut for an entire family of LED luminaires. When Chromasync is enabled, color consistency between luminaires is achieved without having to manually adjust color points on each luminaire.
- Complies with ASTM B117 corrosion resistance standard for > 1,500 hours and ANSI C136.31-2010 standard with a 3G vibration rating.
- Features an innovative, redesigned optical system that improves the quality of light from each LED, enhancing the color uniformity and color mixing capabilities of each Burst Powercore IntelliHue luminaire.
- Improves durability with new flat lens that prevents water from pooling into the luminaire, keeping the LEDs protected and secure over the course of a luminaire's lifetime.
- Integrates patented Powercore technology that controls power output to luminaires directly from line voltage – rapidly, efficiently, and accurately. The Color Kinetics Data Enabler Pro merges line voltage with control data and delivers them to luminaires over a single standard cable, dramatically simplifying installation and lowering total system cost.
- Universal power input range of 100 to 277 VAC.
- Works seamlessly with the complete Color Kinetics line of controllers, including ColorDial Pro, iPlayer 3, and Light System Manager – as well as third-party controllers.

For detailed product information, please refer to the Burst Product Guide at www.colorkinetics.com/global/products/intellihue/burst-powercore-gen3-intellihue/

Specifications

Due to continuous improvements and innovations, specifications may change without notice.

Output

Beam Angle	8°
Lumens All Channels Full On †	1,860
Lumens @ 2700 K	1,259
Lumens @ 4000 K	1,371
Lumens per channel	R 363 / G 613 / B 142 / MW 768
Efficacy (lm/W) All Channels Full On	59.1
Efficacy (lm/W) @ 2700 K	67.4
Efficacy (lm/W) @ 4000 K	66.1
CRI @ 2700 K	79.5
CRI @ 4000 K	82.1
LED Channels	Red/Green/Blue/Mint White

Electrical

Input Voltage	100 to 277 VAC, auto-ranging, 50/60 Hz
Power Consumption	31.3
(Maximum at full output, steady state)	
Power Factor	> 0.9 @ 100 to 240 VAC > 0.85 @ 277 VAC
Surge Limits ¶	1 kV maximum differential (L to N) 2 kV maximum common (L to Gnd or N to Gnd)

For additional Surge Protection Requirements for LED Lighting Systems, please refer to www.colorkinetics.com/KB/surge-protection.

Control

Interface	Data Enabler Pro (DMX or Ethernet)
Control Channels	4 channels per luminaire

For additional Control Channel information, please refer to <https://colorkinetics.helpdocs.io/article/fv5rkvclq>.

Control System

Color Kinetics full range of controllers, including Light System Manager, iPlayer 3, Antumbra iColor Keypad, and ColorDial Pro, or third-party controllers

Remote Monitoring & Management Works with Interact Landmark

Lumen Maintenance

Threshold§	Ambient Temperature	Reported ¶¶	Calculated ¶¶
L ₉₀	25 °C	>39,715	>39,715
	50 °C	>39,715	>39,715
L ₈₀	25 °C	>60,000	>98,607
	50 °C	>60,000	>98,607
L ₇₀	25 °C	>60,000	>100,000
	50 °C	>60,000	>100,000
L ₅₀	25 °C	-	>100,000
	50 °C	-	>100,000

† Lumen measurement complies with IES LM-79-08 testing procedures.

§ L50 = 50% lumen maintenance (when light output drops below 50% of initial output). All values are given at B10, or the median value where 90% of the LED population is better than the reported or calculated lumen maintenance measurement.

¶ Minimum surge limits per IEC 61547, tested in accordance with IEC 61000-4-5.

¶¶ Lumen maintenance figures are based on lifetime prediction graphs supplied by LED source manufacturers. Whenever possible, figures use measurements that comply with IES LM-80-08 testing procedures. In accordance with TM-21-11, Reported values represent the interpolated value based on six times the LM-80-08 total test duration (in hours). Calculated values represent time durations that exceed six times the total test duration.

Physical

Dimensions (Height x Width x Depth)	287 x 210 x 186 mm (11.3 x 8.3 x 7.3 in)
Weight	5.5 kg (12.1 lb)
Effective Projected Area (EPA)	0.026 m ² (0.28 ft ²) (Luminaire plus Full Glare Shield)
Housing Material	Die-cast aluminium, white powder-coated finish
Lens	Clear tempered glass
Luminaire Connections	1.8 m (6 ft) combined power data whip

Temperature Ranges

-40 to 50 °C (-40 to 122 °F) Operating
 -20 to 50 °C (-4 to 122 °F) Startup
 -40 to 80 °C (-40 to 176 °F) Storage

Vibration Resistance

Complies with ANSI C136.31, 3G
 Mechanical Impact IK08

Corrosion Resistance

Complies with ASTM B117 standard for > 1,500 hours
 Humidity 0 to 95%, non-condensing

Thermal Protection enabled

For additional Thermal Protection information, please refer to <https://colorkinetics.helpdocs.io/article/sh301ducix>

Luminaire Run Lengths

To calculate luminaire run lengths and total power consumption for your specific installation, download the Configuration Calculator from www.colorkinetics.com/support/install_tool/

Certification and Safety

Approbation UL/cUL, FCC Class A, CE, PSE, RCM
 Environment Dry/Damp/Wet Location, IP66
 For additional Energy Efficiency Class Information, please refer to <https://colorkinetics.helpdocs.io/article/cvis2p8qq>.



Dimensions

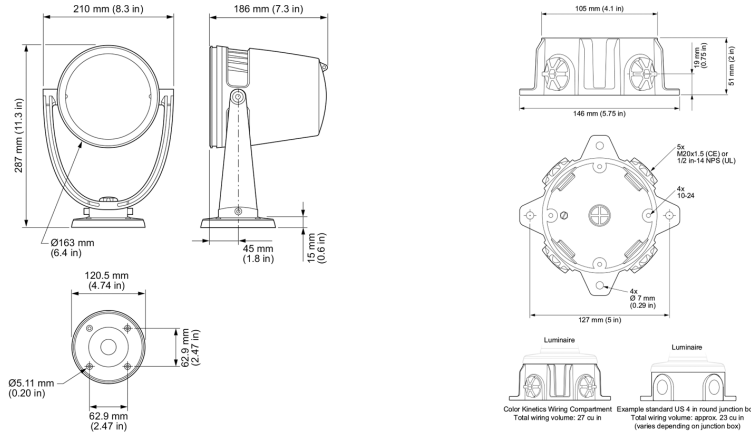

Photometrics 8° native (no spread lens)

Photometric data is based on test results from an independent NIST traceable testing lab. IES data is available at www.colorkinetics.com/global/support/ies.

Beam Angle	8°
LEDs	All channels full on
Lumens All Channels Full On	1,860.0
Efficacy (lm/W) All Channels Full On	59.1

Illuminance at Distance

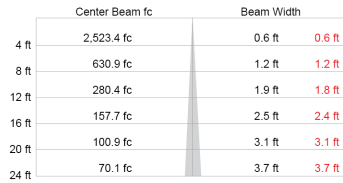

Zonal Lumen

Zone	Lumens	% Luminaire
0-30	1772.8	95.8%
0-40	1813.5	98.0%
0-60	1841.6	99.5%
60-90	4.2	0.2%
8-100	1.6	0.1%
90-120	0.5	0.0%
0-90	1845.8	99.7%
90-180	4.9	0.3%
0-180	1850.7	100.0%

Polar Candela Distribution

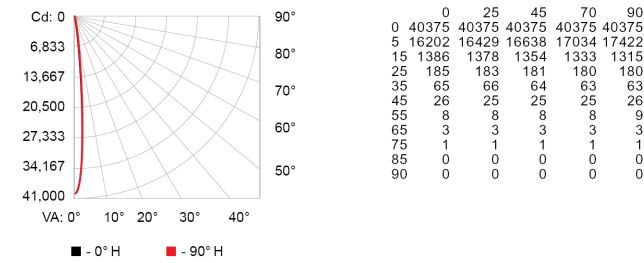

62.8 m (206 ft) 1 fc maximum distance

For lux multiply fc by 10.7

Coefficients of Utilization - Zonal Cavity Method

Effective Floor Cavity Reflectance: 20%

RCC %:	80	70	50	30	10	0										
RW %:	70	50	30	0	70	50	30	0	50	30	20	50	30	20	0	
RCR:	0	1.19	1.19	1.19	1.16	1.16	1.00	1.11	1.11	1.11	1.06	1.06	1.06	1.02	1.02	1.00
1	1.16	1.14	1.12	1.11	1.13	1.12	1.10	0.98	1.08	1.07	1.06	1.04	1.03	1.03	1.01	1.00
2	1.13	1.10	1.07	1.05	1.11	1.08	1.06	0.97	1.05	1.03	1.02	1.02	1.01	1.00	1.00	0.99
3	1.10	1.06	1.03	1.01	1.08	1.05	1.02	0.95	1.03	1.01	0.99	1.00	0.99	0.97	0.98	0.96
4	1.08	1.04	1.00	0.98	1.06	1.02	1.00	0.94	1.01	0.98	0.96	0.99	0.95	0.95	0.97	0.96
5	1.06	1.01	0.98	0.95	1.04	1.00	0.97	0.92	0.99	0.96	0.94	0.97	0.95	0.93	0.96	0.94
6	1.04	0.99	0.96	0.93	1.03	0.98	0.95	0.91	0.97	0.94	0.92	0.96	0.94	0.92	0.95	0.93
7	1.02	0.97	0.94	0.92	1.01	0.97	0.94	0.90	0.95	0.93	0.91	0.95	0.92	0.91	0.94	0.92
8	1.00	0.95	0.92	0.90	1.00	0.95	0.92	0.89	0.94	0.91	0.89	0.93	0.91	0.89	0.93	0.90
9	0.99	0.94	0.91	0.89	0.98	0.93	0.91	0.88	0.93	0.90	0.88	0.92	0.90	0.88	0.91	0.89
10	0.97	0.93	0.90	0.88	0.97	0.92	0.89	0.87	0.92	0.89	0.87	0.91	0.89	0.87	0.90	0.88

Photometrics 2700 K

Beam Angle	8°
LEDs at	2700 K
Lumens @ 2700 K	1,259
Efficacy (lm/W) @ 2700 K	67.4

Illuminance at Distance

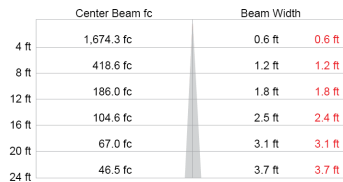

Zonal Lumen

Zone	Lumens	% Luminaire
0-30	1205.1	95.7%
0-40	1232.8	97.9%
0-60	1251.5	99.4%
60-90	3.3	0.3%
70-100	1.5	0.1%
90-120	0.8	0.1%
0-90	1254.8	99.7%
90-180	4.2	0.3%
0-180	1259.0	100.0%

Polar Candela Distribution

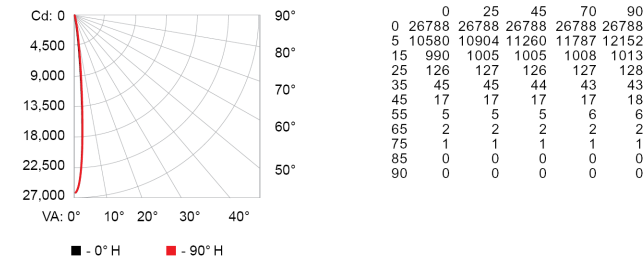

48.8 m (160 ft) 1 fc maximum distance

For lux multiply fc by 10.7

Coefficients of Utilization - Zonal Cavity Method

Effective Floor Cavity Reflectance: 20%

RCC %:	80	70	50	30	10	0										
RW %:	70	50	30	0	70	50	30	0	50	30	20	50	30	20	0	
RCR:	0	1.19	1.19	1.19	1.16	1.16	1.00	1.11	1.11	1.11	1.06	1.06	1.06	1.02	1.02	1.00
1	1.16	1.14	1.12	1.11	1.13	1.12	1.10	0.98	1.08	1.07	1.06	1.04	1.03	1.03	1.01	1.00
2	1.13	1.10	1.07	1.05	1.11	1.08	1.06	0.96	1.05	1.03	1.02	1.02	1.01	1.00	0.99	0.97
3	1.10	1.06	1.03	1.01	1.08	1.05	1.02	0.95	1.03	1.01	0.99	1.00	0.99	0.97	0.98	0.96
4	1.08	1.03	1.00	0.98	1.06	1.02	0.99	0.93	1.00	0.98	0.96	0.99	0.97	0.95	0.97	0.95
5	1.06	1.01	0.98	0.95	1.04	1.00	0.97	0.92	0.98	0.96	0.94	0.97	0.95	0.93	0.96	0.94
6	1.04	0.99	0.96	0.93	1.02	0.98	0.95	0.91	0.97	0.94	0.92	0.96	0.93	0.92	0.94	0.93
7	1.02	0.97	0.94	0.91	1.01	0.96	0.93	0.90	0.95	0.93	0.91	0.94	0.92	0.90	0.93	0.91
8	1.00	0.95	0.92	0.90	0.99	0.95	0.92	0.88	0.94	0.91	0.89	0.93	0.91	0.89	0.92	0.90
9	0.99	0.94	0.90	0.88	0.98	0.93	0.90	0.87	0.92	0.89	0.88	0.92	0.89	0.88	0.91	0.89
10	0.97	0.92	0.89	0.87	0.96	0.92	0.89	0.86	0.91	0.89	0.87	0.91	0.88	0.87	0.90	0.88

Photometrics 4000 K

Photometric data is based on test results from an independent NIST traceable testing lab. IES data is available at www.colorkinetics.com/global/support/ies.

Beam Angle	8°
LEDs at	4000 K
Lumens @ 4000 K	1,371
Efficacy (lm/W) @ 4000 K	66.1

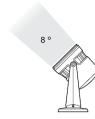

Illuminance at Distance

	Center Beam fc	Beam Width	
4 ft	1,814.6 fc	0.6 ft	0.6 ft
8 ft	453.7 fc	1.2 ft	1.2 ft
12 ft	201.6 fc	1.8 ft	1.8 ft
16 ft	113.4 fc	2.5 ft	2.4 ft
20 ft	72.6 fc	3.1 ft	3.1 ft
24 ft	50.4 fc	3.7 ft	3.7 ft

51.2 m (168 ft)
1 fc maximum distance

■ Vert. Spread: 8.8°
■ Horiz. Spread: 8.7°

Zonal Lumen

Zone	Lumens	% Luminaire
0-30	1306.1	95.7%
0-40	1336.1	97.9%
0-60	1356.4	99.4%
60-90	3.5	0.3%
70-100	1.7	0.1%
90-120	0.9	0.1%
0-90	1360.0	99.7%
90-180	4.6	0.3%
0-180	1364.6	100.0%

For lux multiply fc by 10.7

Polar Candela Distribution

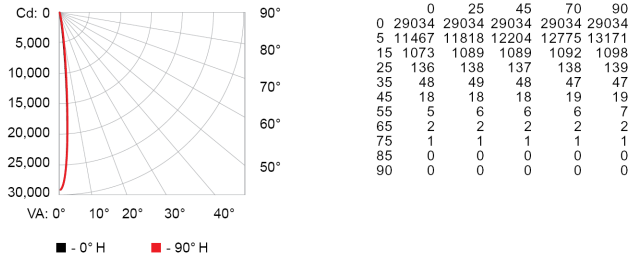

Coefficients of Utilization - Zonal Cavity Method

Effective Floor Cavity Reflectance: 20%

RCC %:	80				70				50				30				10				0
RW %:	70	50	30	0	70	50	30	0	50	30	20	50	30	20	50	30	20	50	30	20	0
RCR:	0	1.19	1.19	1.19	1.16	1.16	1.16	1.00	1.11	1.11	1.11	1.06	1.06	1.06	1.02	1.02	1.02	1.00	1.00	1.00	1.00
	1	1.16	1.14	1.12	1.11	1.13	1.12	1.10	0.98	1.08	1.07	1.06	1.04	1.03	1.02	1.01	1.00	0.99	0.99	0.98	0.98
	2	1.13	1.10	1.07	1.05	1.11	1.08	1.06	0.96	1.05	1.03	1.02	1.02	1.01	0.99	0.99	0.98	0.97	0.96	0.96	0.96
	3	1.10	1.06	1.03	1.01	1.08	1.05	1.02	0.95	1.03	1.00	0.99	1.00	0.99	0.97	0.96	0.95	0.94	0.94	0.94	0.94
	4	1.08	1.03	1.00	0.98	1.06	1.02	0.99	0.93	1.00	0.98	0.96	0.99	0.97	0.95	0.97	0.95	0.94	0.94	0.93	0.93
	5	1.06	1.01	0.98	0.95	1.04	1.00	0.97	0.92	0.98	0.96	0.94	0.97	0.95	0.93	0.96	0.94	0.92	0.91	0.91	0.91
	6	1.04	0.99	0.95	0.93	1.02	0.98	0.95	0.91	0.97	0.94	0.92	0.96	0.93	0.92	0.94	0.93	0.91	0.90	0.89	0.89
	7	1.02	0.97	0.94	0.91	1.01	0.96	0.93	0.90	0.95	0.93	0.91	0.94	0.92	0.90	0.93	0.91	0.90	0.89	0.88	0.88
	8	1.00	0.95	0.92	0.90	0.99	0.95	0.92	0.88	0.94	0.91	0.89	0.93	0.91	0.89	0.92	0.90	0.89	0.88	0.88	0.88
	9	0.99	0.94	0.90	0.88	0.98	0.93	0.90	0.87	0.92	0.90	0.88	0.92	0.89	0.88	0.91	0.89	0.88	0.87	0.87	0.87
	10	0.97	0.92	0.89	0.87	0.96	0.92	0.89	0.86	0.91	0.89	0.87	0.91	0.88	0.87	0.90	0.88	0.86	0.86	0.86	0.86

Luminaire and Accessories

Use Item Number when ordering in North America

Luminaire	Item Number	Item 12NC
Burst Powercore gen3, IntelliHue, White Housing, Architectural	423-000029-27	912400137733
Accessories		
Trim Ring gen2, White	120-000189-22	912400135451
Half Glare Shield gen2, White	120-000189-26	912400135455
Full Glare Shield gen2, White	120-000189-30	912400135459
Louver	120-000189-17	912400133447
Spread Lens, 10°	120-000189-18	912400135371
Spread Lens, 20°	120-000189-12	912400133442
Spread Lens, 40°	120-000189-13	912400133443
Spread Lens, 60°	120-000189-14	912400133444
Spread Lens, 80°	120-000189-15	912400133445
Spread Lens, 10°x40°	120-000189-16	912400133446
Mounting Arm, Short, Gray	120-000206-00	912400136642
Mounting Arm, Medium, Gray	120-000206-01	912400136643
Mounting Arm, Long, Gray	120-000206-02	912400136644
Wiring Compartment, 4 in diameter, White, CE (cover not included)	106-000011-41	910503703276
Wiring Compartment, 4 in diameter, White, UL (cover not included)	106-000011-31	910503704148
Power Supplies		
Data Enabler Pro, 3/4 in / 1/2 in NPT (U.S. trade size conduit)	106-000004-00	910503701210
Data Enabler Pro, PG21/PG13 (metric size conduit)	106-000004-01	910503701211

