

- NOTES:**
- EACH PDS-500s WILL SUPPORT 1 RUN OF ICOLOR ACCENT USING THE 50 FT. LEADER CABLES (SOLD SEPARATELY).
 - EACH 50 FT. LEADER CABLE SUPPORTS A MAX. OF 8 LINEAR FT. OF ICOLOR ACCENT FIXTURES. FOR A TOTAL MAX. OF 8 L.F. PER PDS60 24V.
 - TOTAL FIXTURES: 8 - 1' ACCENT, 2 - 4' ACCENT, 1 - 8' ACCENT.
 - USE A TERMINATOR (INCL. W/ LEADER CABLE) AT THE END OF EACH FIXTURE RUN.
 - IF USING 1' JUMPER CABLES (SOLD SEPARATELY) YOU MUST SUBTRACT AND CUT TOTAL NUMBER USED FROM LEADER CABLE.

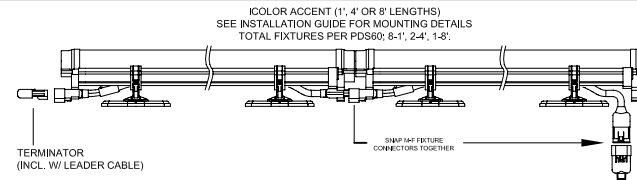

ICOLOR ACCENT 50 FT. LEADER CABLE
(MAX. 1 PER PDS60 - DO NOT EXTEND)

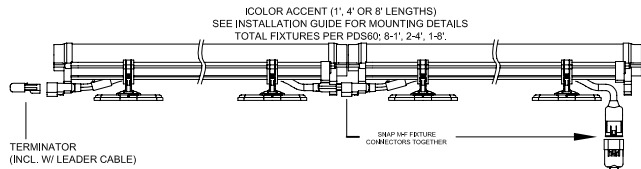
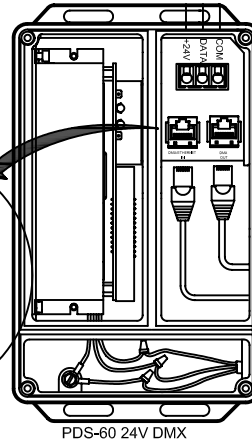
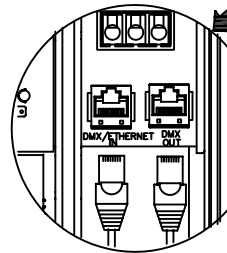
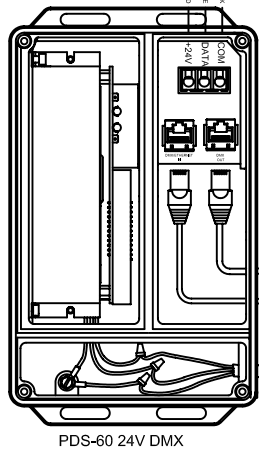

CONTINUE DMX OUT/IN SEQUENCE TO INCLUDE ALL PWR/DATA SUPPLIES, THEN TERMINATE THE LAST UNIT (SEE BELOW)

CAT 5/RJ45 DATA CABLE (UTP 24 AWG 4 PAIR)

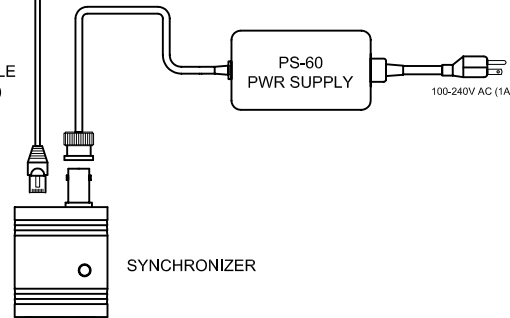

NOTE:

- USE AN IN-LINE DMX REPEATER AFTER EVERY 16th PDS UNIT IN A CHAIN, OR WHEN A DATA CABLE RUN BETWEEN UNITS EXCEEDS 400 FEET.
- MAXIMUM NUMBER OF FIXTURES PER PDS-60: 8-1', 2-4', 1-8'

DATA TERMINATOR



PLACE IN LAST DMX OUT PORT OF POWER/DATA SUPPLY CHAIN

CAT-5/RJ45 PIN-OUT

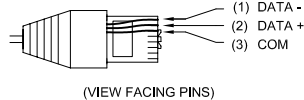

COLOR KINETICS INCORPORATED
10 MILK STREET, SUITE 1100
BOSTON, MA 02108
888 FULL RGB
617 423 9999
WWW.COLORKINETICS.COM

"FULL SPECTRUM DIGITAL LIGHTING"

TITLE:

SYSTEM WIRING DIAGRAM (TYP)

PRODUCTS:

ACCENT / PDS-60 24V / SYN / P60

DATE:

DWG. BY: S.D.

SCALE: NTS

REV:

PAGE: 1 OF 1