

OUTPUT TO LIGHTS

REFER TO YOUR DLE DATA SHEET FOR SPECIFIC WIRING DETAILS

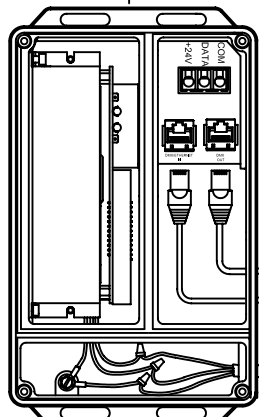

PDS-60 24V DMX

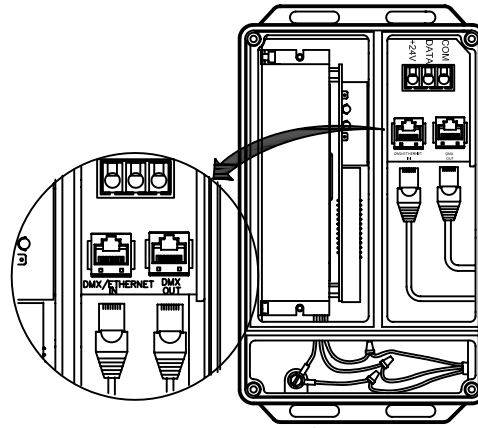

PDS-60 24V DMX

CONTINUE DMX OUT/IN SEQUENCE TO INCLUDE ALL PWR/DATA SUPPLIES, THEN TERMINATE THE LAST UNIT (SEE BELOW)

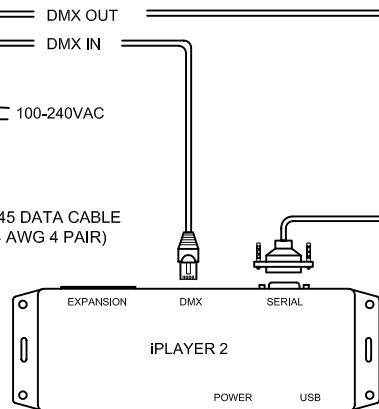

CAT 5/RJ45 DATA CABLE (UTP 24 AWG 4 PAIR)

SERIAL CABLE (20' INCL./50' MAX.)

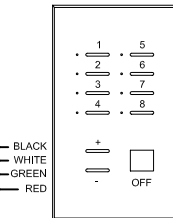

CONTROLLER KEYPAD

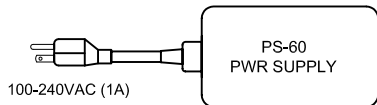

PS-60 PWR SUPPLY

NOTE:

- USE AN IN-LINE DMX REPEATER AFTER EVERY 16th PDS UNIT IN A CHAIN, OR WHEN A DATA CABLE RUN BETWEEN UNITS EXCEEDS 400 FEET.
- MAXIMUM NUMBER OF FIXTURES PER PDS-60: 1

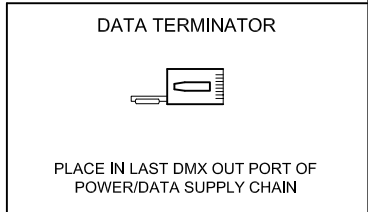

CAT-5/RJ45 PIN-OUT

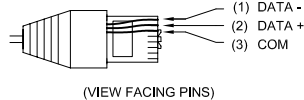

COLOR KINETICS INCORPORATED
10 MILK STREET, SUITE 1100
BOSTON, MA 02108
888 FULL RGB
617 423 9999
WWW.COLORKINETICS.COM

"FULL SPECTRUM DIGITAL LIGHTING"

TITLE:

SYSTEM WIRING DIAGRAM (TYP)

PRODUCTS:

PDS-60 24V / iPlayer2 / PS60 / Controller Keypad

DATE:

DWG. BY: S.D.

SCALE: NTS

REV:

PAGE: 1 OF 1